

UFII Surgical Kit Kit Code | UF 07

- Kit composed of drill with outstanding cutting force and durability, etc.
- UFII Narrow $\varnothing 3.0$ $\varnothing 3.3$ / UFII Regular $\varnothing 3.8$ $\varnothing 4.0$ $\varnothing 4.5$ $\varnothing 5.0$ $\varnothing 5.5$ Fixture

Unit mm | Drill Scale 1 : 0.9

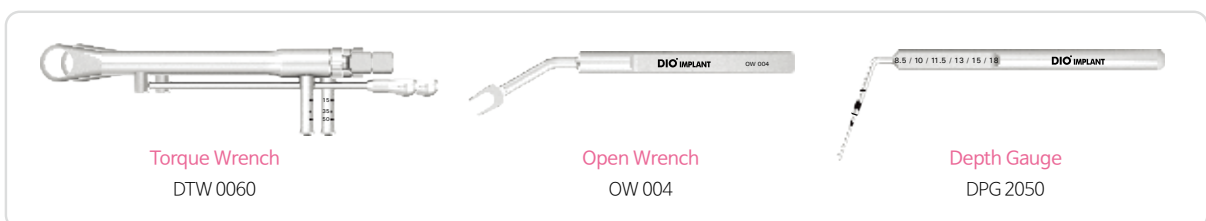
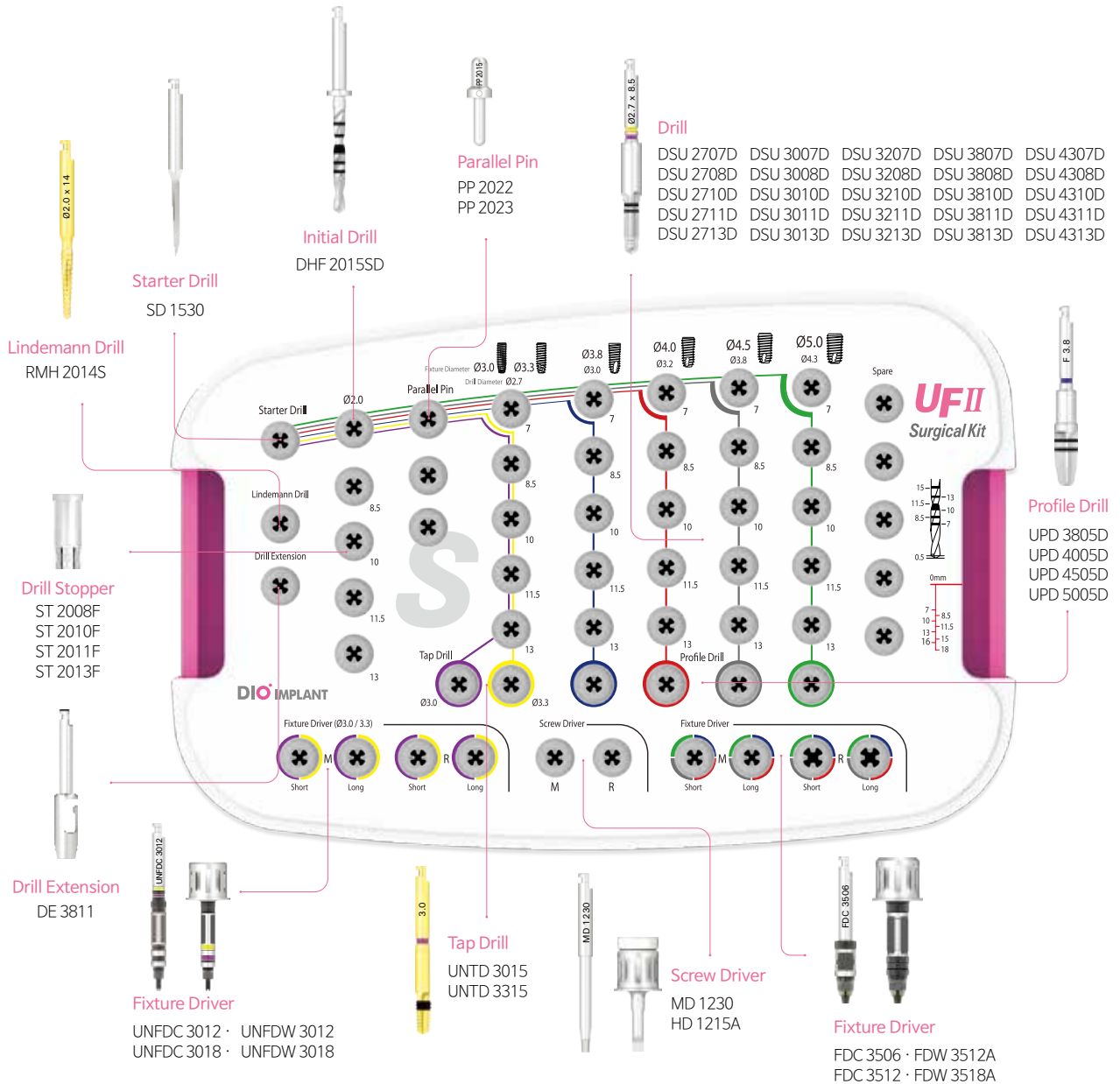

Surgical Tool

Starter Drill

K

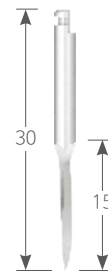

Unit mm | Scale 1 : 1.15

Code

SD 1530

Initial Drill

K D Ø2.0 · Only use UFII Master Kit

Unit mm | Scale 1 : 1

Code

DSU 2007D

DSU 2008D

DSU 2010D

DSU 2011D

DSU 2013D

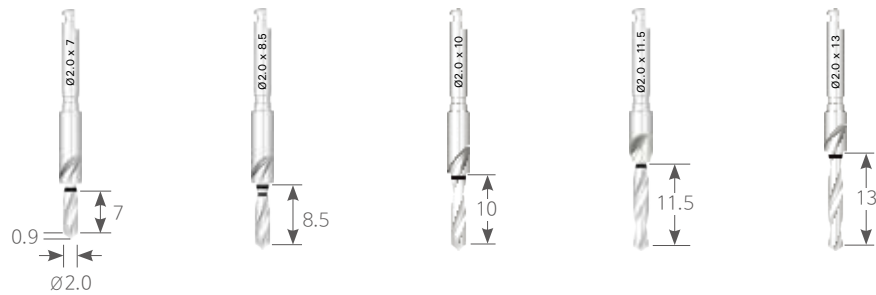

K D Ø2.0 · Only use UFII Surgical Kit

Unit mm | Scale 1 : 1.2

Code

DHF 2015SD

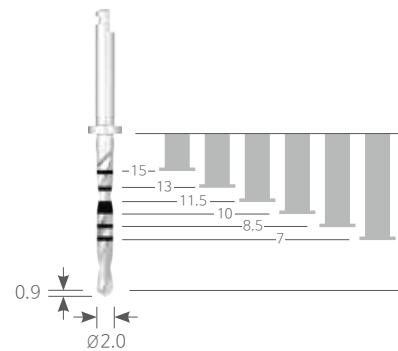

Drill stopper

K D Ø2.0 · Only use UFII Surgical Kit

● Sold separately

Unit mm | Scale 1 : 1

Code

ST 2015F

ST 2013F

ST 2011F

ST 2010F

ST 2008F



Parallel Pin

● Sold separately

K

Unit mm | Scale 1 : 1

| | | | | | |
|------|----------------|----------------|----------------|---------|---------|
| Code | PP 1223 | PP 1523 | PP 2015 | PP 2022 | PP 2023 |
| | | | | | |

Path Pin

● Sold separately

K

Unit mm | Scale 1 : 1.2

| | |
|------|-----------------|
| Code | DPP 3512 |
|------|-----------------|



Lindemann Drill

Unit mm | Scale 1 : 1.2

K D Ø2.0

| | |
|------|------------------|
| Code | RMH 2014S |
|------|------------------|

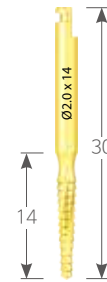

Positioning Guide

● Sold separately

K D Ø2.0

| | |
|------|----------------|
| Code | PG 0060 |
|------|----------------|



Angled Path Pin

● Sold separately

K

Unit mm | Scale 1 : 1.15

| | | |
|------|------------------|------------------|
| Code | DAP 4515A | DAP 4515B |
|------|------------------|------------------|



Type

Hex A

Hex B

Surgical Tool

Drill

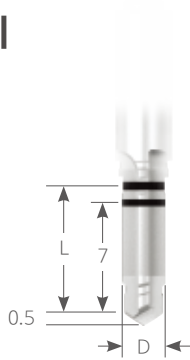

Color |



Scale 1 : 1.15

K D Ø2.6

● Sold separately

Unit mm | Scale 1 : 1

| Code | DSU 2707D | DSU 2708D | DSU 2710D | DSU 2711D | DSU 2713D | DSU 2715D | DSU 2718D |
|------|-----------|-----------|-----------|-----------|-----------|-----------|-----------|
|------|-----------|-----------|-----------|-----------|-----------|-----------|-----------|



Length

7

8.5

10

11.5

13

15

18

K D Ø2.9

Unit mm | Scale 1 : 1

| Code | DSU 3007D | DSU 3008D | DSU 3010D | DSU 3011D | DSU 3013D | DSU 3015D | DSU 3018D |
|------|-----------|-----------|-----------|-----------|-----------|-----------|-----------|
|------|-----------|-----------|-----------|-----------|-----------|-----------|-----------|



Length

7

8.5

10

11.5

13

15

18

K D Ø3.1

Unit mm | Scale 1 : 1

| Code | DSU3207D | DSU3208D | DSU 3210D | DSU 3211D | DSU 3213D | DSU 3215D | DSU 3218D |
|------|----------|----------|-----------|-----------|-----------|-----------|-----------|
|------|----------|----------|-----------|-----------|-----------|-----------|-----------|



Length

7

8.5

10

11.5

13

15

18

K D Ø3.7

Unit mm | Scale 1:1

| | | | | | | | |
|------|-----------|-----------|-----------|-----------|-----------|------------------|------------------|
| Code | DSU 3807D | DSU 3808D | DSU 3810D | DSU 3811D | DSU 3813D | DSU 3815D | DSU 3818D |
|------|-----------|-----------|-----------|-----------|-----------|------------------|------------------|



K D Ø4.2

Unit mm | Scale 1:1

| | | | | | | | |
|------|----------|----------|-----------|-----------|-----------|------------------|------------------|
| Code | DSU4307D | DSU4308D | DSU 4310D | DSU 4311D | DSU 4313D | DSU 4315D | DSU 4318D |
|------|----------|----------|-----------|-----------|-----------|------------------|------------------|



K D Ø4.7

Unit mm | Scale 1:1

| | | | | | | |
|------|------------------|------------------|------------------|------------------|------------------|------------------|
| Code | DSU 4808D | DSU 4810D | DSU 4811D | DSU 4813D | DSU 4815D | DSU 4818D |
|------|------------------|------------------|------------------|------------------|------------------|------------------|

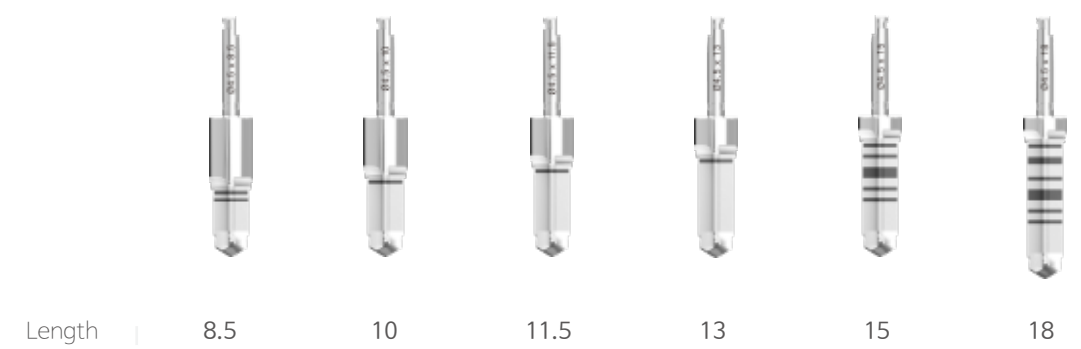

Surgical Tool

Profile Drill

K

● Sold separately

Unit mm | Scale 1:1

| | | | | | |
|--------------|-----------|-----------|-----------|-----------|-----------|
| Fixture Size | Ø3.8 | Ø4.0 | Ø4.5 | Ø5.0 | Ø5.5 |
| Code | UPD 3805D | UPD 4005D | UPD 4505D | UPD 5005D | UPD 5505D |



Color



Tap Drill

K

Unit mm | Scale 1:1

| | | | | | | | |
|--------------|-----------|-----------|-------------|-------------|-------------|-------------|-------------|
| Fixture Size | Ø3.0 | Ø3.3 | Ø3.8 | Ø4.0 | Ø4.5 | Ø5.0 | Ø5.5 |
| Code | UNTD 3015 | UNTD 3315 | UT(II) 3815 | UT(II) 4015 | UT(II) 4515 | UT(II) 5015 | UT(II) 5515 |

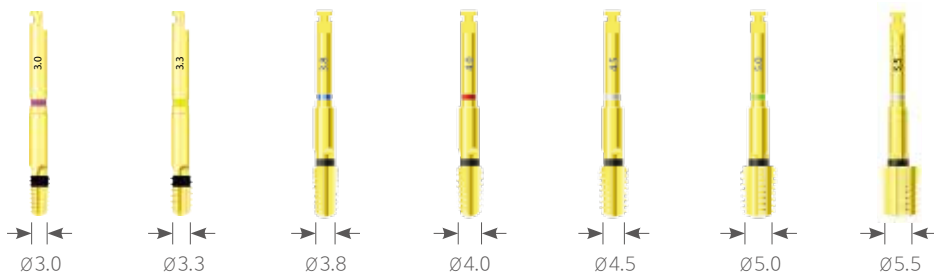

Color



Drill Extension



K

Unit mm | Scale 1:1.2

| | |
|------|---------|
| Code | DE 3811 |
|------|---------|

Fixture Driver Narrow

● Sold separately

K Machine

Unit mm | Scale 1:1

| | | | |
|------|-------------------|------------|------------|
| Code | UNFDC 3006 | UNFDC 3012 | UNFDC 3018 |
|------|-------------------|------------|------------|



K Ratchet

| | | | |
|------|-------------------|------------|------------|
| Code | UNFDW 3006 | UNFDW 3012 | UNFDW 3018 |
|------|-------------------|------------|------------|

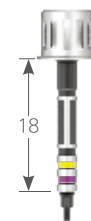
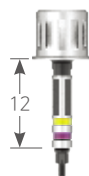

Fixture Driver Regular / Wide

● Sold separately

K Machine

Unit mm | Scale 1:1

| | | | |
|------|----------|----------|-----------------|
| Code | FDC 3506 | FDC 3512 | FDC 3518 |
|------|----------|----------|-----------------|

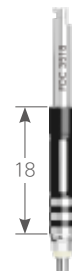
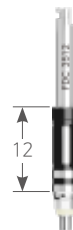

K Ratchet

| | | | |
|------|------------------|-----------|-----------|
| Code | FDW 3506A | FDW 3512A | FDW 3518A |
|------|------------------|-----------|-----------|

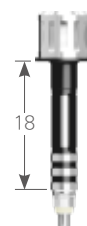
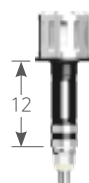
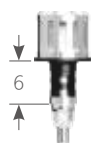

Surgical Tool

Screw Driver Machine

● Sold separately

Unit mm | Scale 1:1

K Slot 0.5

| | | |
|------|---------|---------|
| Code | MD 0522 | MD 0530 |
|------|---------|---------|



K Hex 0.9

| | | |
|------|---------|---------|
| Code | MD 0922 | MD 0930 |
|------|---------|---------|

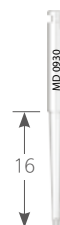

K Hex 1.2

| | | | | | |
|------|---------|---------|---------|---------|---------|
| Code | MD 1219 | MD 1222 | MD 1230 | MD 1234 | MD 1239 |
|------|---------|---------|---------|---------|---------|



K Torx 1.7

| | | | |
|------|---------|---------|---------|
| Code | MD 1719 | MD 1722 | MD 1730 |
|------|---------|---------|---------|



Screw Driver Ratchet

● Sold separately

K Slot 0.5

Unit mm | Scale 1:1

| | | |
|------|----------|----------|
| Code | HD 0510A | HD 0515A |
|------|----------|----------|

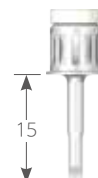
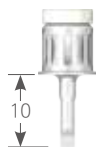

K Hex 0.9

| | | | |
|------|----------|----------|----------|
| Code | HD 0910A | HD 0915A | HD 0920A |
|------|----------|----------|----------|

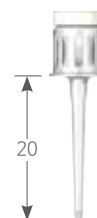
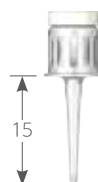
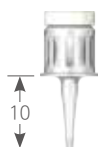

K Hex 1.2

| | | | | | | |
|------|----------|----------|----------|----------|----------|----------|
| Code | HD 1205A | HD 1210A | HD 1215A | HD 1220A | HD 1225A | HD 1230A |
|------|----------|----------|----------|----------|----------|----------|

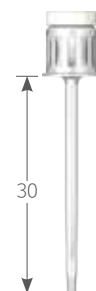
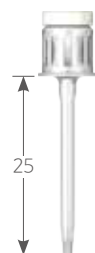
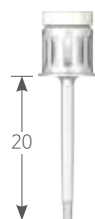
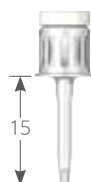
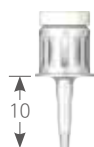

K Torx 1.7

| | | | | | |
|------|----------|----------|----------|----------|----------|
| Code | HD 1705A | HD 1710A | HD 1715A | HD 1720A | HD 1725A |
|------|----------|----------|----------|----------|----------|

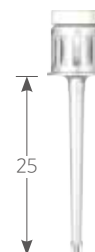
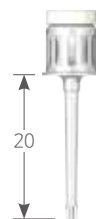
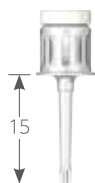
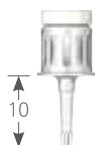
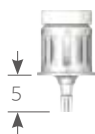

Surgical Tool

Fixture Mount Driver

· Only use UF II Master Kit

K Hex 2.5

Unit mm | Scale 1 : 1

| Type | Machine | | Ratchet | |
|------|-----------|-----------|------------|------------|
| Code | MHDC 2520 | MHDC 2525 | MHDR 2513A | MHDR 2518A |



Solid Abutment Driver

· Only use UF II Master Kit

K

Unit mm | Scale 1 : 1.2

| | | |
|--------|---|----|
| Length | 6 | 12 |
|--------|---|----|

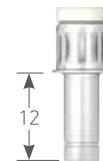
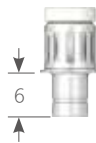

| | | |
|---------------|-----------|-----------|
| Diameter Ø4.5 | HDS 4506A | HDS 4512A |
| Ø5.5 | HDS 5506A | HDS 5512A |
| Ø6.5 | HDS 6506A | HDS 6512A |

Ball Abutment Driver

· Only use UF II Master Kit

● Sold separately

K Unit mm | Scale 1:1

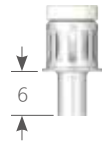
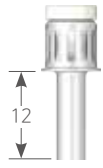
| Code | HD 2406A | HD 2412A |
|------|---|---|
| |  |  |

Abutment Removing Driver

· Only use UF II Master Kit

Unit mm | Scale 1:1

K Unit mm | Scale 1:1

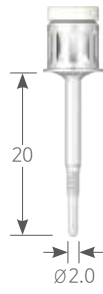
| Code | HARD 20315A | HARD 20320A |
|------|---|---|
| |  |  |

Surgical Tool

Depth Gauge

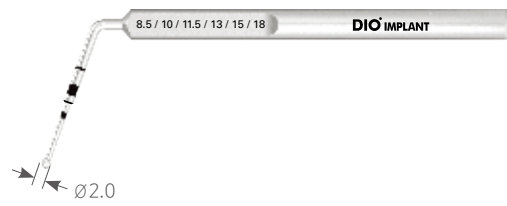

K D Ø2.0

Unit mm | Scale 1 : 1

Code

DPG 2050

Open Wrench

- Used to remove Mount if the bone is soft.
- 30 ° Neck angle for convenience in intraoral insertion.



K

Unit mm | Scale 1 : 1

Code

OW 004

Torque Wrench



K

Unit mm | Scale 1 : 1

Code

DTW 0060